



Night Friends

Bats of the Americas



On-line Activity Guide



batcon.org
**BAT CONSERVATION
INTERNATIONAL**



© Merlin D. Tuttle, Bat Conservation International, www.batcon.org



©David V. / Shutterstock.com



© Merlin D. Tuttle, Bat Conservation International, www.batcon.org



© Vlaincreverte / Shutterstock.com

Background

Origins and Relatives

Did you know that the world's smallest mammal, the bumblebee bat, weighs less than a penny?

Bats play a vital role in the health of our natural world, and are fascinating creatures. They are a group of mammals belong to the mammalian order "Chiroptera" which in Greek means hand-wing. All living bat species fit into one of two sub-groups, the Microchiroptera or the Megachiroptera. Members of the latter group are often called "flying foxes" because of their fox-like faces.

Diversity and Distribution

The more than 1,260 species of bats make up approximately 20 percent of all mammal species, more than any other mammal group except rodents, and they are found everywhere in the world except in the most extreme desert and polar regions. Some 47 species live in the United States and Canada, but the majority inhabit tropical forests where, in total number of species, they sometimes outnumber all other mammals combined. Bats come in an amazing variety of sizes and appearances. While the bumblebee bat is at one extreme, some flying foxes of the Old World tropics have wingspans of up to six feet. The big-eyed, winsome expressions of flying foxes often surprise people who would never had thought that a bat could be cute. Some bats have long angora-like fur, ranging in color from bright red-brown or yellow to jet black or white. One species is

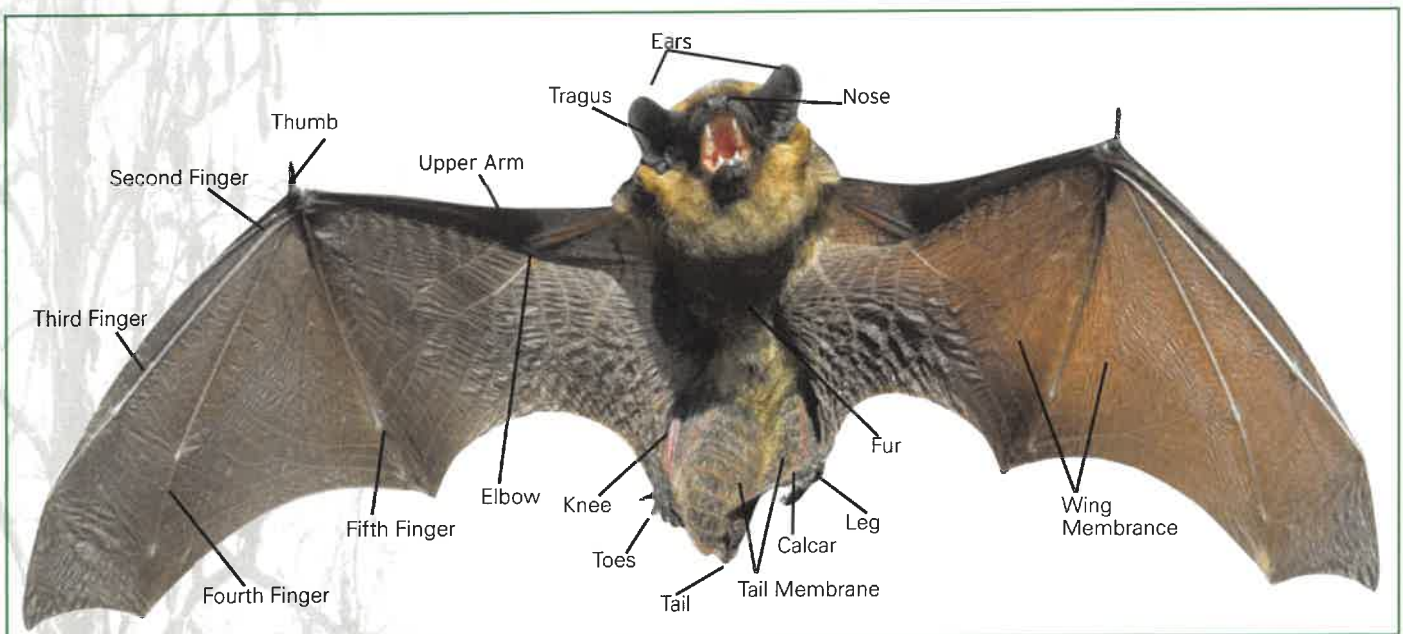

©Kirsanov / Shutterstock.com

©Linda Bucklin / Shutterstock.com ; @scosi09 / Shutterstock.com

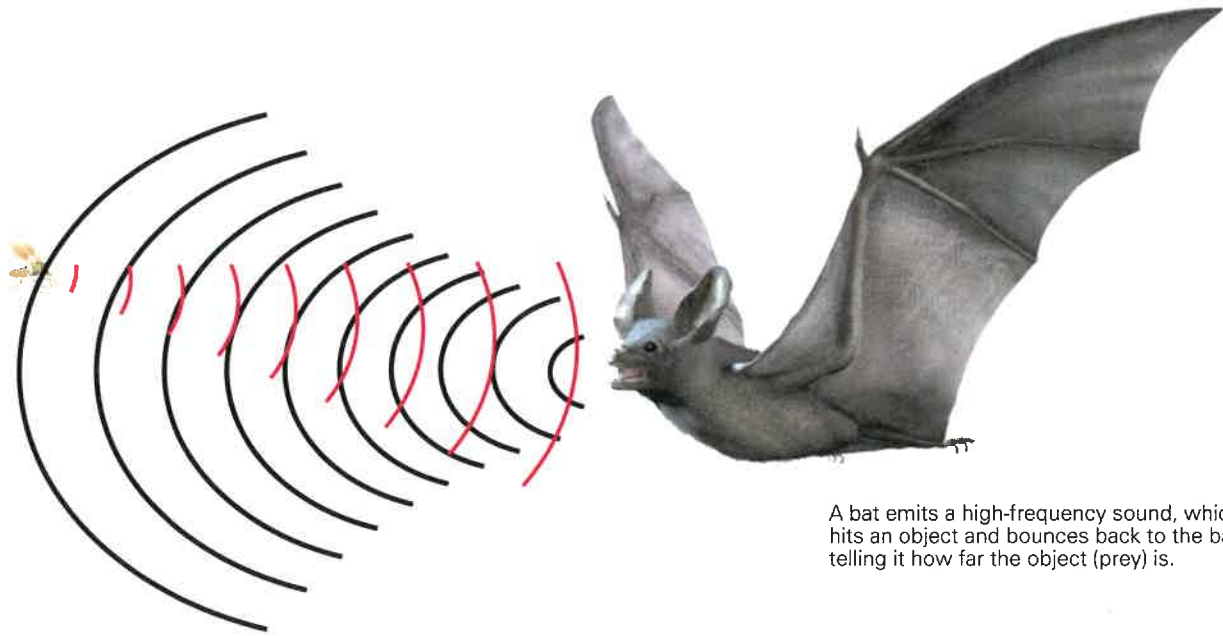

A bat emits a high-frequency sound, which hits an object and bounces back to the bat, telling it how far the object (prey) is.

furless, and another even has pink wings and ears. A few are so brightly patterned that they are known as butterfly bats. Others have enormous ears, nose leaves, and intricate facial features that become more fascinating when their sophisticated role in navigation is explored.

Navigation and Migration

Like dolphins, most bats communicate and navigate with high-frequency sounds, which they bounce off objects to determine where and how far they are. Using sound alone, bats can “see” everything but color, and in total darkness they can detect obstacles as fine as a human hair. The sophistication of these unique echolocation systems surpasses current scientific understanding and has been estimated to be billions of times more efficient than any similar system

*Young bats
grow rapidly,
often learning
to fly within
three weeks.*

developed by humans. In addition, bats are not blind and many have excellent vision.

In temperate regions, cold winters and the subsequent lack of insect prey force bats to migrate or hibernate. Most travel fewer than 300 miles to find a suitable cave or abandoned mine, where they may remain for more than six months, surviving solely on stored fat reserves. However, several species are long-distance migrators, traveling from as far north as Canada to the Gulf states or Mexico for the winter. A few species can survive short-term exposure to sub-freezing temperatures, enabling them to overwinter in crevices in cliff faces or inside the outer walls of buildings.

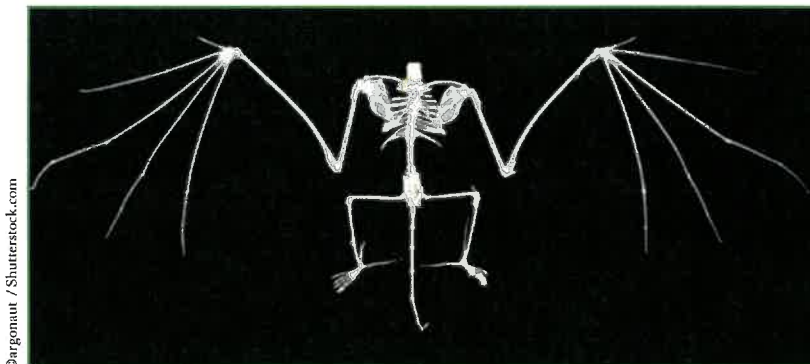

©argonaut / Shutterstock.com

Skelton image of bat

Proportion of bat species with each kind of bat diet.

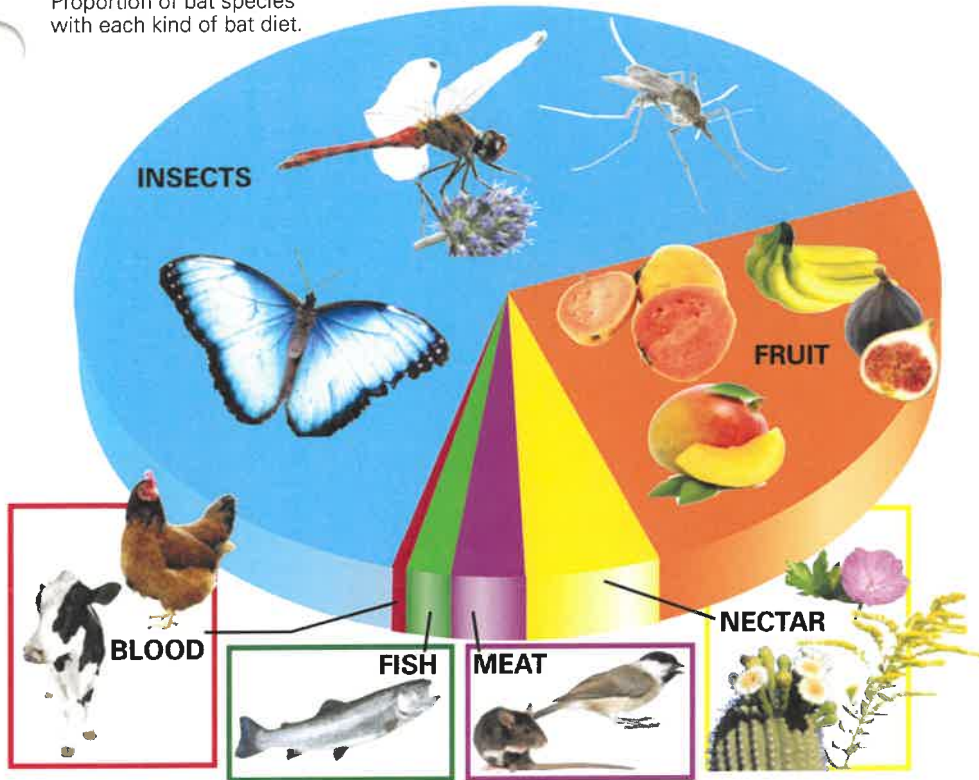

Butterfly ©Kamira / Shutterstock.com; Dragonfly ©alle / Shutterstock.com; Mosquito ©Henrik Larsson / Shutterstock.com; Bananas ©Kasiap / Shutterstock.com; Guava ©ruzanna / Shutterstock.com; Mango ©Yasonya / Shutterstock.com; Fig ©Ultimathule / Shutterstock.com; Cow ©Eric Isselée / Shutterstock.com; Chicken ©s_oleg / Shutterstock.com; Fish ©Melinda Pawver / Shutterstock.com; Rat ©Oleg Kozlov / Shutterstock.com; Marsh Tit ©xpixel / Shutterstock.com; Saguaro cactus bloom ©Bill Florence / Shutterstock.com; Phlox ©Dainis Derics / Shutterstock.com; Golden rod ©Mike Truchon

*Seeds dropped
by bats can
account for up to
95 percent of
forest regrowth
on cleared land.*

Food

Although approximately 70 percent of the world's bats eat insects, many tropical species feed exclusively on fruit or nectar. A few are carnivorous, hunting small vertebrates such as fish, frogs, mice, and birds. Despite their notoriety, there are only three species of vampire bats, their preferred hosts are in two of the species, birds, and in the third, mostly forest mammals and livestock, and live only in Latin America. With the exception of three species of nectar-feeding bats that live along the Mexican border of Arizona and Texas, all bats in the United States and Canada are insectivorous.

Courtship and Reproduction

Most bats that live in temperate regions, such as the United States and Canada, mate in the fall just before entering hibernation. Ovulation and fertilization (through sperm that have been dormant in the female reproductive tract since the previous fall) occur in the spring as females emerge from hibernation. Pregnant females then move from hibernating sites to warmer roosts, where they form nursery colonies. Birth occurs approximately a month and a half to two months later. Young bats grow rapidly, often learning to fly within three weeks. While they are being reared, males and non-reproductive females often segregate into separate groups called maternity and bachelor colonies.



©van Slanic / Shutterstock.com



©EcoPrint / Shutterstock.com

Shelter

Bats can be found roosting in a wide range of shelters, although they are best known for living in caves. Tropical species occupy an even wider range of roost sites than temperate species. For example, some make tent-like roosts by biting through the midribs of large leaves, and several species have suction discs on their wings and feet that enable them to live in the slick-walled cavities formed by unfurling leaves, such as those of the banana plant. Others live in animal burrows, flowers, termite nests, and even in large tropical spider webs. Despite the wide variety of roosts used by bats, many species have adapted to living in roosts of only one or a few types and cannot survive anywhere else.

Why Should I Care about Bats?

Worldwide, bats play essential roles in keeping populations of night-flying insects in balance. Just one bat can catch hundreds of insects in an hour, and large colonies catch tons of insects nightly, including beetle and moth species that cost American farmers and foresters billions of dollars annually, not to mention mosquitoes in our backyards. In a single midsummer night, the millions of free-tailed bats from Bracken Cave in central Texas eat scores of tons of insects!

Throughout the tropics, the seed dispersal and pollination activities of fruit- and nectar-eating bats are vital to the survival of rain forests, with some bats acting as “keystone”

species. Each of these species of bats supports plants that are crucial to entire ecosystems. Many plants bloom at night, using unique odors and special flower shapes that attract bats. The famous baobab tree of the eastern African savannas is a good example. Only bats can approach from below in a manner likely to contact the flower’s reproductive organs and achieve pollination.

Wild varieties of many of the world’s most economically valuable crop plants also rely on bats for survival. Some of the better-known commercial products include fruits such as bananas, breadfruit, avocados, dates, figs, peaches, and mangoes. Others include cloves, cashews, carob, balsa wood, and even tequila.

We already know that more than 300 plant species in the Old World tropics alone rely on the pollinating and seed dispersal services of bats, and additional bat-plant relationships are constantly being discovered. These plants provide more than 450 economically important products, valued in the hundreds of millions of dollars annually. The value of tropical bats in reforestation alone is enormous. Seeds dropped by bats can account for up to 95 percent of forest regrowth on cleared land. Performing this essential role puts these bats among the most important seed-dispersing animals of both the Old and New World tropics.

Excerpted with permission from “The World of Bats” in America’s Neighborhood Bats by Merlin Tuttle, Copyright ©1988. Courtesy of the University of Texas Press.

Featured Bats

Macrotus californicus, California leaf-nosed bat



The California leaf-nosed bat is the only bat in the United States to have both large ears and a nose leaf. It is also one of the most acrobatic fliers. This bat is a “gleaner,” which

means it is one of the few U.S. bats that swoops down to capture insect prey straight from the ground or plants rather than in flight. It typically hunts within a few feet of the ground, using its superior eyesight and hearing to search for insects such as crickets, grasshoppers, beetles, and sphinx moths. California leaf-nosed bats do not hibernate, nor do they migrate. They can be found in desert scrub habitats in the Colorado River valley in southern California, Nevada, and Arizona, and throughout western Mexico.

Antrozous pallidus, pallid bat

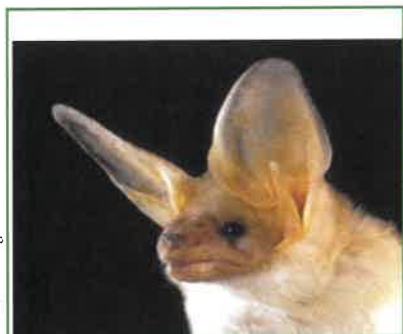

The pallid bat has large ears, but no nose leaf. It is another gleaner that feeds mostly from the ground, unlike the majority of North American bats, which capture flying

prey. With its huge ears, it can detect insects simply by listening for footsteps, and it can respond accurately to a split-second sound from up to 16 feet away. Its most common prey include crickets, beetles, grasshoppers, and even centipedes and scorpions. Pallid bats roost in rock crevices, buildings, and bridges in arid regions. They are found from Mexico and the southwestern United States north through Oregon, Washington, and western Canada.

Lasiurus borealis, red bat



Red bats are North America’s most abundant “tree bats.” They are found east of the Rocky Mountains from central Canada to central Florida wherever there are trees. Red

bats roost in tree foliage, where their rusty red color makes them look like dead leaves. They are perfectly camouflaged as they hang by a single foot with their furry tails curled around them. Red bats are solitary, coming together only to mate and to migrate. Unlike most bats, red bats often give birth to twins and can have litters of up to five young, though three is average. In the fall they perform long-distance migrations, travelling the same routes along the Atlantic seaboard as many small birds do.

Euderma maculatum, spotted bat



The spotted bat is one of America’s most striking mammals. Its long, silky fur is snow white beneath and jet black above, with large white spots on its

shoulders and rump. Its translucent pink ears, nearly as long as its body, are the largest of any bat found in the United States, and it has pink wings to match! Initially thought to be extremely rare, the spotted bat is now known to live from southwestern Canada, south through the western United States to northern Mexico. It is hard to find because it roosts high up in cliff-face crevices and emerges to feed late at night. Moths that are caught high above the ground are its favorite prey.

Investigating Bat Adaptations

Summary:

Students investigate adaptations that increase a bat's chance of finding food and surviving in a particular habitat.

Grade Level:

3-6

Time:

two activity periods

Subject:

science

Skills:

observation, comparison, hypothesizing

Learning Objectives:

Students will be able to:

- List several different foods that bats eat.
- Describe anatomical features that lend themselves to particular bat diets.
- Analyze bat features to accurately predict their diets.

Materials:

- Bats Adapt for Food cards (one set of six cards for each group)
- Bat Food Clues at the end of the lesson, paper for students to write answers

Background

Did you ever stop to think what the world would be like if all animals suddenly tried to eat just one kind of food? What if they all decided to eat just grass? The answer is simple. They soon would run out of grass and starve to death. Because animals eat a wide variety of foods, they compete less, allowing many different species of animals to live in the same habitat and maintain healthy ecosystems.

Most of the world's bats eat insects, and in areas with cold winters, that is all they eat. Many tropical bats eat fruit and nectar, and a few are carnivores that eat other animals, including rats and mice, small birds, frogs, lizards, or even fish. Only three out of more than 1,260 species of bats lap blood.

Each species of bat is adapted for the food it eats. Some bats specialize in eating just one or a few kinds of food, but others are generalists that eat a

©Eric Issele / Shutterstock.com



wide variety of foods. Long-nosed bats have noses of varied lengths and widths that match the sizes and shapes of the flowers from which they drink nectar. Carollia fruit bats are adapted to feeding almost entirely on small piper fruits, but some flying foxes are generalists that eat many sizes and kinds of fruit as well as nectar.

Some bats that catch insects have adaptations for hunting certain kinds of prey or for capturing them in certain places. Free-tailed bats are like little jet airplanes, using their long, narrow wings and far-reaching echolocation (sonar systems) for chasing moths high in the sky. California leaf-nosed bats are more like helicopters, relying on short, broad wings to snatch crickets and other insects from plants or the

© Merlin D. Turtle, Bat Conservation International, www.batcon.org



ground. They can use their extra-large eyes and ears to find insects without even using echolocation. Big brown bats have especially strong jaws and teeth for chewing hard beetles. Perimyotis (common name tri-color bat) have tiny teeth for eating gnats and mosquitoes, and gray myotis have large feet for catching mayflies as they hatch from a pond's surface.

Most experienced bat scientists can guess what a bat eats by looking closely at its adaptations. Long, narrow wings or large tail membranes are usually adaptations for catching insects, but if the bat also has huge feet and claws, it probably eats fish.

Just having large feet, but not overly large, would indicate a bat that catches insects from pond surfaces. If a bat is large and has strong jaws, long canine teeth, and a large tail membrane, it is probably a carnivore, adapted both to eating meat and to turning quickly while chasing prey.

If it has strong jaws and long canine teeth, but has only a very small tail membrane, it is a fruit bat that does not need to chase prey, but is adapted for biting into tough-skinned fruit to squeeze the juice out. Both insect-eating and meat-eating bats always have long tails or tail membranes, but meat-eaters are the largest and have the strongest jaws.

Special adaptations allow bats to find and eat certain kinds of food with little or no competition from other species. This is very successful as long as their unique food type is abundant, but such specialization is risky, because the kinds of prey, fruit, or flowers a bat eats might die out, leaving the bat to starve. Animals that eat a variety of foods can switch types if one disappears, but they cannot compete well with specialized animals for any one food. Most specialists, such as the huge-footed fishing bats, or long-nosed nectar bats, live only in tropical areas where climates and food sources are the most predictable. Bats that live in northern climates, where changes are

frequent and unpredictable, are all insect-eaters that seldom specialize on any one insect type. In these places, it is rare to find a bat with highly specialized wings, feet, or ears.

Preparation

Make enough copies of the Bats Adapt for Food cards to distribute one complete set to each group. You may want to laminate the cards for durability.

Procedure

1. Divide your class into groups of six or more students each.
2. Distribute one complete set of Food Cards to each group. Tell the group to divide the fact cards among its members so that every student can become an expert on one of the bat eating habits. (Two students can share a single card in groups having more than six students.)
3. Ask students to take out a piece of paper and number it from one to twelve down the left-hand side. Ask questions by reading the "Bat Food Clues" to the class one at a time.
4. Give each group a minute or two to discuss each given clue, and decide what type of bat it is (for example, insect-eating, fruit-eating, etc.).
5. After all Bat Food Clues are given and students have written their answers, go back through the 'Bat Food Clues' and lead the class in discussing the answers. Bonus questions after each Bat Food Clue can be used to stimulate additional discussion. Each group's expert on each feeding type can be called upon

to help lead discussions.

Extensions

- Challenge students to investigate other animals that have food habits similar to bats. For example, some birds snatch insects out of the air, while others pick them from foliage. *How do the habits and habitats of these birds compare with those of bats? What about fruit-eating birds? Nectar-eating birds? Fish-eating birds? Are there any other animals that eat blood?* Students can present their results in poster* or report format.
- Create a Bat-Friendly Habitat to support bats and other wildlife. Provide food, water, cover and places to raise wildlife – different bats require different sources of food and places to live. Your habitat can also support other wildlife by planning and planting native plants, adding features like toad adobes and adding puddling areas for butterflies and bats alike. NWF's Schoolyard Habitats program provides step-by-step guide to bat and

©Hal Brindley / Shutterstock.com



wildlife habitats. (www.nwf.org/schoolyard)

- Have students research local bats in their community and work with the Cooperative Extension service and other wildlife rescue leagues to determine the best locations for bats to gather. Students will then organize a sundown hike to watch for bats with fellow students or community members. Learn more about bats their behaviors at [http://Bates LIVE.pwnet.org](http://BatesLIVE.pwnet.org) or participate in citizen science through NWF's Wildlife Watch (www.nwf.org/watch) or Project Noah (www.projectnoah.org)

For example, bats can fold their wings around them to protect them from the elements, so they'd make a great mascot for umbrellas or raincoats. Or bats could advertise insect repellent since they eat mosquitoes. Or maybe aircraft manufacturers, since bats use radar. Sports teams? Night vision goggles?

- Have students create a Halloween card with a bat on it to mail to their grandparents or friends.** Inside, they could include a "Did You Know?" section listing interesting facts they learned about bats.

** Products may be submitted to Bat Conservation International, Department of Education. Original and outstanding works may be posted on-line. ** See examples from Bat Conservation International at www.batcon.org.*

Assessment

- Have students write letters to advertisers they select, explaining why they think a bat would make the perfect mascot for their product.* Students could apply their knowledge of bat characteristics and make their own connections to products.

©dean bertonecchi / Shutterstock.com



Teacher Reference Sheet

Bat Food Clues

WHO AM I? 1

CLUE: My toes and claws are exceptionally long, and the sides of my toes and claws are flat.

BONUS QUESTIONS: What is the advantage of having long toes and claws? What is the advantage of having flattened toes and claws?

ANSWERS: 1. I am a fish-eating bat. Can reach into water without submerging body. To glide easily through water.

WHO AM I? 2

CLUE: My legs are extra strong and my kidneys work quickly so I can eliminate water as fast as I eat.

BONUS QUESTIONS: How do fast-working kidneys help a blood-eating bat? What is the advantage of extra strong legs?

ANSWERS: 2. I am a blood-eating bat. To get rid of the water, so the bat won't be too heavy to fly. To walk on the ground while stalking large prey or to jump away quickly if the prey wakes.

WHO AM I? 3

CLUE: I am a large, strong bat with large ears and broad wings.

BONUS QUESTIONS: Why does a carnivorous bat need big ears? What is the advantage of having broad wings?

ANSWERS: 3. I am a meat-eating bat. To listen to and find prey. To better lift heavy prey.

WHO AM I? 4

CLUE: I fly fast over quiet water, searching for tiny moving objects. My fur is oily.

BONUS QUESTIONS: What is the advantage of flying over calm water? What is the advantage of oily fur?

ANSWERS: 4. I am a fish-eating bat. To easily detect tiny fin tips using echolocation. To shed water, keep bat fur dry, and avoid getting cold.

WHO AM I? 5

CLUE: My short, broad wings and my large tail membrane allow me to dart in and out of branches.

BONUS QUESTIONS: What is the advantage of being able to dart in and out of branches? What is the advantage of being able to catch insects on the ground or in bushes?

ANSWERS: 5. I am an insect-eating bat that catches prey on the ground or on plants. To avoid obstacles and catch prey. To avoid competing for food with other bats that feed in the open.

WHO AM I? 6

CLUE: I have sharp teeth and strong jaws that can cut or crush big meals. I also have a big tail membrane.

BONUS QUESTIONS: What is the advantage of having sharp teeth and strong jaws? What is the advantage of a big tail membrane?

ANSWERS: 6. I am a meat-eating bat. To quickly kill and cut up large prey and break bones. To maneuver better when chasing prey.

Bat Food Clues

WHO AM I?

7

CLUE: My teeth are small, except for my front teeth, which are sharp and can cut like a razor. My nose can detect heat.

BONUS QUESTIONS: Why are razor-sharp teeth important? What is the advantage of a heat-sensitive nose?

ANSWERS: 7. I am a blood-eating bat. To make quick, painless cuts. To find areas on prey that are rich in blood.

WHO AM I?

8

CLUE: I have sophisticated echolocation abilities; long, narrow wings; and small ears.

BONUS QUESTIONS: Why do bats have echolocation as well as good eyesight? What advantages do long, narrow wings have?

ANSWERS: 8. I am an insect-eating bat that catches prey in the air. To pursue prey on the darkest nights and to roost in deep, dark caves where they are safe from predators. To chase fast-flying insects and travel far.

WHO AM I?

9

CLUE: I can smell my food from a long way off and I don't have to echolocate.

BONUS QUESTIONS: Why do many of these bats not need to echolocate? Why is a good sense of smell important?

ANSWERS: 9. I am a fruit-eating bat. They don't live in caves and echolocation isn't necessary for finding fruit. To smell ripe fruits, because color can't be seen in the dark.

WHO AM I?

10

CLUE: My tongue is long and my wings allow me to hover.

BONUS QUESTIONS: Why does this bat need to hover in flight? What is the value of a long tongue?

ANSWERS: 10. I am a nectar-eating bat. To visit flowers rapidly without landing, therefore staying safe from predators. To reach deep in to flowers and lap up nectar.

WHO AM I?

11

CLUE: My teeth are flat and my jaws are strong so I can squeeze juice from my food.

BONUS QUESTIONS: Why does this bat discard as much pulp as possible? What is the advantage of having flat teeth?

ANSWERS: 11. I am a fruit-eating bat. To get the most nutritious part of the fruit without carrying extra weight. To squeeze out juice without cutting up the pulp.

WHO AM I?

12

CLUE: My nose is long and narrow and my teeth are very small.

BONUS QUESTIONS: What is the advantage of small teeth? What is the advantage of a long, narrow nose?

ANSWERS: 12. I am a nectar-eating bat. Nectar doesn't need to be chewed, so heavy teeth aren't needed. To reach deep into long, narrow flowers.

Bats Adapt for Food Cards

Worksheet

1



MEAT-EATING BAT

© Merlin D. Tuttle, Bat Conservation International, www.batcon.org

RANGER RICK'S WILDLIFE SAFARI GAME

Scientific Name: Carnivore (CAR-nih-vore)

Body: Large size for capturing and carrying off other animals.

Head: Strong jaws for killing prey; large ears help identify and locate a mouse's footsteps or the call of a frog.

Wings: Broad, with up to three-foot wingspan; large tail membrane for maneuvering rapidly.

Teeth: Sharp molars and long canines for chopping flesh and crushing bones.

National Wildlife Federation • www.nwf.org



FISH-EATING BAT

© Merlin D. Tuttle, Bat Conservation International, www.batcon.org

RANGER RICK'S WILDLIFE SAFARI GAME

Scientific Name: Piscivore (PISK-kah-vore)

Body: Larger than average size; long legs and enormous feet; long, sharp, hooked claws; toes flat for knifing through water; oily fur that sheds water to keep dry.

Head: Strong jaws for killing and chewing fish; special echolocation ability to detect ripples or fins on water surface.

Wings: Narrow and long for flying fast over water.

Teeth: Sharp (similar to insectivores), for chopping and grinding fish.

National Wildlife Federation • www.nwf.org



BLOOD-EATING BAT

© Merlin D. Tuttle, Bat Conservation International, www.batcon.org

RANGER RICK'S WILDLIFE SAFARI GAME

Scientific Name: Sanguivore (SAN-guee-vore)

Body: Strong legs for walking on ground or climbing on prey and for jumping into flight when full of blood.

Head: Heat-sensitive nose helps find blood vessels closest to prey's skin surface; short pug muzzle makes biting easier.

Wings: Broad and short; strong enough to carry heavy food loads with a full stomach.

Teeth: Tiny molars; incisors forming large, razor-sharp blades for slicing prey's skin; grooved tongue for lapping blood; special saliva keeps blood from clotting so bat can keep drinking.

Special: Kidneys allow bat to urinate as fast as it eats to lighten the load before flying home

National Wildlife Federation • www.nwf.org



INSECT-EATING BAT

© Merlin D. Tuttle, Bat Conservation International, www.batcon.org

RANGER RICK'S WILDLIFE SAFARI GAME

Scientific Name: Insectivore (in-SECK-tee-vore)

Body: Many body shapes, all small.

Head: Many kinds of faces and ears that aid echolocation and hearing while hunting for insects.

Wings: Insectivores that catch insects on the ground or on plants (gleaning insectivores) have broad, short wings and large tail membranes for darting in and out of branches or hovering close to the ground. Insectivores that chase insects in the air while flying (aerial insectivores) have longer, narrower wings and often have smaller ears for streamlining; some use their tail membrane to help catch prey.

Teeth: Sharp, for grinding and chopping tough insect bodies.

National Wildlife Federation • www.nwf.org

Bats Adapt for Food Cards

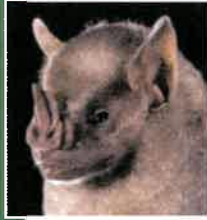

FRUIT-EATING BAT

© Merlin D. Tuttle, Bat Conservation International, www.batcon.org

RANGER RICK'S WILDLIFE SAFARI GAME

Scientific Name: Frugivore (FROO-gee-vore)

Body: Often large with bright colors; most have no tail and little or no tail membrane.

Head: Medium to short snouts; keen nose for smelling ripe fruit; strong jaws for biting fruit; large eyes with excellent vision; many don't echolocate.

Wings: Wide and short for carrying heavy fruits; small tail membrane.

Teeth: Wide, flat grinding teeth and strong jaws for crushing fruit-separates juice and spits out pulp; some have grooved teeth to more easily collect juice.

National Wildlife Federation • www.nwf.org



NECTAR-EATING BAT

© Merlin D. Tuttle, Bat Conservation International, www.batcon.org

RANGER RICK'S WILDLIFE SAFARI GAME

Scientific Name: Nectarivore (NEC-ta-ree-vore)

Body: Small body

Head: Long, slender snout fits perfectly into flowers; long, delicate jaw; grooved lower lip and rough, scaly tongue to catch nectar; excellent vision; and sense of smell.

Wings: Short and wide with long wingtips for hovering above flowers.

Teeth: Small; not used much for chewing due to liquid diet.

National Wildlife Federation • www.nwf.org

Did you know...

- Desert ecosystems rely on nectar-feeding bats to pollinate giant cacti, including the organ pipe and saguaro of Arizona.
- Agricultural plants from bananas to cashews, dates, and figs rely on bats for pollination and seed dispersal.
- More than half of American bats species are considered endangered due to disturbance of roosting bats in caves, loss of habitat including forested areas, and inappropriate use of pesticides.
- Mexican free-tailed bats can fly 10,000 feet high.
- Townsend's-big eared bats can pluck insects from foliage.
- Hibernating little brown bats can stop breathing for almost an hour during hibernation to reduce their energy needs.
- Fishing bats have an echolocation system so sophisticated they can detect a minnow's fin as fine as a human hair.
- All bats living in the United States and Canada eat insects, except 3 species of nectar-feeding bats living along the Texas-Arizona border.
- Bats consume large quantities of "bugs" such as mosquitoes, and are a natural form of insect control.
- Bats are the only flying mammals and comprise the second largest order of mammals in the world
- A bat's grasp is strong enough to hold its entire body weight while its body hangs upside down.



©beilizar/Shutterstock.com

Bats: Maligned or Malicious?

Summary:

Students explore their views of a threatened bat and present their findings.

Grade Levels:

3-8; K-2

Time:

Two or more class periods, depending on the presentations.

Subjects:

science, reading, presentation, social studies

Skills:

analysis, application, classification, comparison, description, evaluation, research, synthesis

Learning Objectives:

Students will be able to:

- Describe several views people hold about bats.
- Identify misconceptions about a threatened species.
- Reflect on changes in their attitudes about wildlife.
- Share natural history and conservation knowledge about bats.

Materials:

- Copies of "Threatened: The Indiana Bat" readings (whichever one is more appropriate for your students' reading level). Each student will need one reading.
- Craft materials (optional)
- Props (optional)

Background

Many of us would much rather see moose, loons, and rabbits on a jaunt in the woods than snakes, spiders, and bats. Because of the way these animals have been portrayed in myths, folklore, books, and movies, many of us are biased towards cute, furry animals, even though all species play important roles in their ecosystems. Although some of our responses to certain wildlife help protect us from danger, logic does not always guide our beliefs and behaviors. Furthermore, we tend to overlook the benefits some species offer humans and other wildlife. For example, spiders and bats help control nuisance insects and provide food for other animals. Many snakes control some rodent populations. Many of our beliefs about animals are not based on scientific facts.

Beneficial Bats

Bats often suffer from negative, Halloween-like associations. Many people think of Dracula, blood-sucking fangs, disease, or bats tangled in the hair. Are these perceptions fair? Do bats drink blood? Only three out of the more than 1,260 species of bats are actually "vampire bats," and these species all live only in Latin



©Serg Zastavkin / Shutterstock.com

America. Virtually all U.S. bats are insect-eaters (there are a few bats in the Southwest that live on nectar and a few species eat fish). Do bats carry disease? Like all animals, bats can carry diseases. Yet public-health worries about bats are exaggerated. The probability of catching a disease from a bat is far less than the risk of being struck by lightning. For anyone who simply leaves bats alone, and never attempts to handle them, they are invaluable allies that need not be feared. However, as with other wild animals, those that can be caught are most likely to be sick, and because these may bite in self-defense, and can transmit potentially dangerous diseases, they never should be handled.

Most of our fears about wildlife are generated from some level of primal fear based simply on the unknown. Bats are small, mysterious creatures of the night that spend time in caves and other dark places. Interestingly,

©Slyve Reinck / Shutterstock.com



in the tropics, where many of the bats are much larger and more easily seen in their habitats, they are not feared.

Due to killing stemming from carelessness, fear of bats, and continued habitat loss, bat populations have suffered. Bats reproduce slowly, typically rearing only one young per year, making population recovery a slow process. Instead of spreading myths, we should consider bats' real roles in ecosystems. Bats are important to the natural world. Feeding at night, they catch billions of insects. Nature's bug-zappers are wonderfully efficient, catching as many as 600 mosquitoes an hour. Bats also eat a number of crop pests, saving farmers between 3 and 53 billion dollars per year by reducing crop damage and the need for harmful pesticides. Many tropical bats feed on fruit or nectar and in the process pollinate plants and disperse seeds, helping to regenerate the forest. Any number of familiar plants depend on bats, including figs, bananas, avocados, cloves, and cashews.

Procedure

1. Tell your students that they will be learning about bats. For fun, ask them to practice making a special sound made by a bat called the "body buzz." The body buzz is a low sound bats make when they are resting and seem contented before they go to sleep. The bat's whole body vibrates.
2. What do your students know about bats, important animals throughout North America? Instruct students to create a concept map for bats. A concept map is a diagram representing thoughts and ideas associated with a certain subject, in this case a bat. Encourage students to record their own ideas and then share with their group; there are no right or wrong answers.
3. Review the concept maps as a class and discuss any commonalities. *How are bats generally perceived by the class? In a positive light? A negative light? Why?*
4. Distribute copies of "Threatened: The Indiana Bat" to each student. (Note: two versions are provided; pick the version with the reading level most appropriate for your students.) Another option is to have students conduct the research themselves. Mention that Indiana bats are threatened species in the United States. There are also many other species of bats throughout North America.
5. Give students time to read about bats.
6. If possible, head outside to evaluate your school grounds or a local area as habitat for bats. *Is there a forest nearby? Are there any caves or streamside trees where bats could roost and feed? Are there trees with peeling bark for bats to hide under?*
7. Back in the classroom, divide the class into small groups of two to three students. Explain that each group will be responsible for designing and sharing a presentation about bats.
8. Give students the following guidelines for their presentations. The presentations might be in the form of a newscast (perhaps interviewing a biologist), skit, radio show, documentary, song, poster, mural, diorama, or other medium. The final presentation should last roughly five minutes. In addition to being fun and creative, the presentations should also convey key, accurate information about bats. One important role of the presentation is to educate people about myths they may have heard about bats. *For example, are bats really blood suckers? What kinds of benefits do bats provide to people and ecosystems?*
9. Let students know they will be evaluated on their presentations. As a class, develop a list of criteria

for judging the presentations. Record the ideas on the board. Encourage students to think about what they believe makes a good presentation. For example: Did the presentation demonstrate how bats really behave? *Did it show us why bats are important? Were the facts correct? Was the information clearly presented? Was the presentation interesting? Creative? Did it change the way classmates think about bats?*

10. Give students time to work in their groups to prepare their presentations. Have additional research materials available, particularly on bat pollination if possible. Also, consider having props available, or put students in charge of finding what they need for their presentations. If time allows, this can develop into a more involved project taking several class periods.
11. Presentation time! Invite student groups to deliver their presentations to the rest of the

class. After each presentation, review the criteria listed on the board as a class and evaluate the presentation. Remind students of the difference between constructive and destructive criticism. Encourage students to begin with positive comments and add suggestions for improvement.

12. To conclude, have students develop a second concept map for bats. Then have students compare their pre- and post-concept maps to reflect on their new understanding of these animals. Discuss some of their results.

Modifications for Younger Students (Grades K-2)

For younger students, introduce the book *Stellaluna*, by Janell Cannon. This delightful story portrays bats in a positive light, following the antics of the young bat Stellaluna as she spends time with a family of birds and discovers her true identity.

Modifications for (Grades 5-8)

Older students can research different species of bats on their own, instead of relying on the readings provided. They could conduct comparisons among different kinds of bats, their diets, habitat requirements, and what plants they may pollinate.

Extensions

- Have students deliver their presentations for other audiences. For example, invite another class, or parents. Or share the presentations with a parent or teacher association.
- *Do bats live in your region? If so, which ones?* Build (or order) bat boxes to make a Schoolyard Habitats® site for bats. Bats are declining in part due to a loss of roosting sites. Providing a place for bats to roost and raise their young can be an exciting project to benefit bats, and a great lead-in to the Schoolyard Habitats project. For details, and more information about bats and bat research projects, consult Bat Conservation International's (BCI) website at www.batcon.org.
- *What other animals suffer from human misconceptions?* Investigate and find out. One example is raptors, such as eagles and hawks. Although they are protected by law, magnificent animals such as eagles were once shot as pests and for sport.





© Dr. Morley Read / Shutterstock.com

Compare the views that various cultures, including Native American nations, have toward eagles and other wildlife species. *Which wildlife species do they like and dislike? Why?*

- Examined up close, bats have beautifully complicated faces and bodies. As a class project, feature a bat beauty contest. Students can find pictures of bats and create detailed drawings of their features. *
- Think of common phrases that refer to bats. For example, “blind as a bat” and “going batty.” Can you think of others? Have students investigate the origin and meaning of these phrases, as well as whether they are fair statements based on bats’ true

behaviors and characteristics.

Assessment

- Compare the perceptions various cultures have regarding bats today and historically. Students might divide into groups (perhaps by region of the world or era) to investigate how these bats are portrayed in myths, stories, art, phrases, and folk tales. Consider a trip to an art or natural history museum to search for information on bats. As follow-up, students can investigate whether the portrayal is fair given the animal’s true behavior.
- For young students, encourage them to list as many adjectives as they can think of that begin

with the letters ‘b’ to describe bats. *Which of the ‘b’ adjectives accurately describe the bat? Do people ever use some of the other adjectives to describe the animals? Which ones? Why? For example, are bats blind and bold or beautiful and beneficial?*

- Pre- and post-concept maps described in the lesson offer a great assessment tool.

Indiana Bat

ACTIVITY

Reading 1

*More than
1,260 different kinds
(i.e., species)
of bats in the world.*



©Adam Mann, Environmental Solutions and Innovations / www.fws.gov

Is a bat a mouse with wings? No, bats are not rodents. Instead, bats belong to their own special group of mammals, Chiroptera. There are more than 1,260 different kinds (i.e., species) of bats in the world. Forty-seven different species live in the United States.

Some bats eat nectar, fruit, or even fish, but almost all of the bats in the United States eat insects. In fact, they eat lots and lots of insects. One bat can eat more than 600 flying insects such as mosquitoes in one hour! They find their food by “echolocation.” They make sounds (which humans

can’t hear) that bounce off other objects and return to their ears. These sounds help them to fly safely and locate their prey.

Many people don’t like bats. People think bats can get tangled in their hair or spread disease. In fact, bats can see and are very good at finding their way around in the dark. A bat can “see” something as fine as a human hair using echolocation. The chance of a bat giving someone a disease is less than the chance of being struck by lightning. In fact, bats are very useful to people. They eat insects

that might damage farmers' plants and help pollinate our crops.

At least six bat species in the United States are endangered. Many bats are disappearing because people misunderstand them or try to get rid of them, and they are losing their habitat. Bats suffer because we disturb the caves and forests they need. The Indiana Bat is one species in trouble. This bat lives in parts of Maine, Vermont, New Hampshire, and New York, as well as states farther south and west. In winter, Indiana bats hibernate in caves with a temperature of 37-43° F. The caves were once filled with bats, but now many of the bats are gone. For example, one cave in Kentucky had at least 100,000 bats in the 1960s, but only 250 by 1987.

Why are bats disappearing? Some people like to explore caves, which may disturb bats while they are hibernating. If bats wake up from hibernation and have to move

around, they will use too much energy and not have enough to survive the winter. Other times, people build cave gates that lock the bats out of their winter homes. Some gates trap air in the caves and make it too hot for the bats. Humans are also changing forests and causing problems for Indiana bats in their summer habitat. Bats like to feed and roost in trees near waterways. But in some areas, these important trees are cleared by logging, driving away the bats. In other places, dams have been constructed, removing the trees near the waterways that bats prefer.

But there is hope! In many places, people have built bat-friendly gates. For example, in Tennessee, people built a special gate that weighs 23 tons. The gate lets bats into their natural habitat but keeps people out of this important place for bats.

Many other animals also like to live and feed in forests next to streams, so if we protect trees next to waterways,

we're protecting habitat for bats and other animals. Since 2006 more than 5.7 million bats have been killed by White-nose Syndrome, a new disease of bats which may cause the extinction of some kinds that were once common. For regular updates on this fast spreading disease, visit www.batcon.org.

What do you think about saving bats?



© Merlin D. Tuttle, Bat Conservation International, www.batcon.org

Indiana Bat

ACTIVITY

Reading 2

*Some bat species are
pollinators of
useful plants,
eating nectar
from blossoms and
carrying pollen
from flower to flower.*

Bats look like mice with wings, but they are not rodents. In fact, they belong to their own group within the class of mammals, and this group is among mammals' most successful. Of the approximately 5,000 species of mammals, nearly a fifth—over 1,260 species—are bats.

A few bats feed on nectar or fruit, but most feed on insects. They have large appetites. A single insect-eating bat, flying through the night sky in pursuit of prey, may eat more than 600 flying insects in one hour. A bat that lives for 30 years may consume several million insects.

Bats are high on the list of animals that are victims of human myths and misunderstandings. Well adapted

to flying at night, bats can navigate in total darkness across a room crisscrossed with strings. They do it by sending out sounds that bounce off of objects and return to the bats' ears, which read them like radar. One myth, that bats generally carry the disease rabies, is also false. Only one-half of one percent (0.5%) of healthy-looking bats examined in one U.S. study was found to be rabid.

On the other hand, bats are useful to people. Some bat species are pollinators of useful plants, eating nectar from blossoms and carrying pollen from flower to flower. Agaves, plants of the desert Southwest used in making fiber ropes and other products, are bat-pollinated. Bats not only help people by eating huge numbers of insects, but bat studies have been important in the development of low-temperature surgery, vaccines, and navigational aids for the blind.

In recent decades, several U.S. bat species have had population declines. In 1973, the Indiana bat became the first of nine U.S. bat species to appear on the Endangered Species List. The story of the Indiana bat shows the problems faced by many of the 45 bat species in the United States. The Indiana bat is roughly the size of a house sparrow, with gray-brown fur and pink to cinnamon underparts. It eats insects, which females and juveniles snatch from the air over streams and trees. Males look for food at treetop level over dense woods. The species can be found in the Midwest and eastern United States, from the western Ozarks



Indiana Bat Range



of Oklahoma north to southern Wisconsin, east to Vermont, and south to Florida.

In winter, the Indiana bat hibernates in limestone caves, especially caves in which temperatures average 37° to 43° F with a relative humidity averaging 74 percent. In summer, Indiana bats live in hilly countryside, along riverbanks, and on low plains. The bats roost under the bark of dead and dying trees in these areas.

The Indiana bat population has been falling since at least the 1960s. For example, in the 1960s, Kentucky had five caves in which more than 150,000 Indiana bats hibernated. By 1988, the total winter population in the five caves was only 49,000. Today, nearly 90 percent of all Indiana bats hibernate in only seven caves.

One of the main reasons that bat numbers are falling is the loss of cave habitat, especially caves used for hibernation. Some caves have been made into tourist attractions. Others have been destroyed by vandals or disturbed by spelunkers (people who explore caves). Since 1950, these and other causes have eliminated and degraded major winter bat colonies of West Virginia, Indiana, and Illinois.



© National Forest Service, www.srs.fs.usda.gov



© National Forest Service, www.srs.fs.usda.gov

Build a Bat House!

Summary:

Students build a bat house for their Backyard Wildlife Habitat™ or Schoolyard Habitats® Site.

Grade Level:

2-8

Time:

2 hours (plus painting and installation time)

Subject:

science, art, math

Skills:

construction, description, analysis

Learning Objectives:

Students will be able to:

- Identify reasons for building a bat house.
- Demonstrate a method for building a bat house.
- Identify key criteria for successful bat houses.

- tape measure or yardstick
- scissors (optional)
- staple gun (optional)

Background

Why Build a Bat House?

America's bats are an invaluable natural resource. Yet, due to decades of unwarranted human fear and habitat loss, bats are in alarming decline. The loss of bats contributes to growing demands for toxic pesticides that increasingly threaten our personal and environmental health.

Materials: (for each house)

- 1/4 sheet (2' x 4') 1/2" CDX (outdoor grade) plywood
No pressure- or chemically-treated wood
- One piece 1' x 2' (3/4" x 1 3/4" finished) x 8" pine (furring strip)
- 20 to 30 1 1/4" coated deck or exterior-grade Phillips screws
- One pint black, water-based stain, exterior-grade
- One pint water-based primer, exterior-grade
- One quart flat water-based paint or stain, exterior-grade*
- One tube paintable latex caulk
- 1" x 3" x 28" board for roof
- 6 to 10 7/8" roofing nails

**Years of research have shown that bat houses are far more successful at attracting bats if they are painted or stained. Painting helps maintain the proper internal temperature for bats and also increases the life span of the bat house. Appropriate color depends upon geographic location and amount of sun exposure. Adjust to*

The most important goal is to preserve America's most abundant bats in sufficient numbers to maintain nature's balance. If you live in areas of bat habitats, putting up a bat house near your home or school can help provide a critical safe haven for bats. Bats make good neighbors; as primary predators of night-flying insects, they play a vital role in maintaining the balance of nature. People with occupied bat houses on their properties benefit from having fewer lawn and garden pests, and they enjoy learning about bats and sharing their knowledge with friends and neighbors. Few efforts on behalf

©gualtiero beffi / Shutterstock.com



darker colors for less sun. Use exterior-quality, water-based stain or latex paint, and choose flat paint rather than gloss or semi-gloss.

Recommended Tools

- table saw (for adults only) or handsaw,
- caulking gun
- variable speed reversing drill
- paintbrushes
- Phillips bit for drill

of wildlife are more fun or rewarding than helping bats.

Note: Some teachers opt to buy ready-to-hang bat houses and concentrate the lesson instead on selecting a good site for mounting it. Superior quality bat houses are available through Bat Conservation International at www.batcon.org.

Looking for additional or other ways to provide better bat habitat? You can try these other simple actions to attract bats to your Backyard Wildlife Habitat or Schoolyard Habitats site, by providing the insects to eat, water to drink, and places to hide that bats need for their habitat.

- Got an anti-bug zapper in your yard? You might want to think

about getting rid of it! Zappers are useless on most biting insects and only kill light-attracted moths, which are good food for bats.

- Trees and shrubs, even dead ones left standing, are excellent hideouts for bats and birds.
- Bats need water to drink. If you build a mini-pond, you'll also attract frogs and many other water creatures. Find out how to do this on NWF's website: www.nwf.org/backyardwildlifehabitat/ or at a garden center or library. Suggestions are also available in *Water for Wildlife* at www.batcon.org
- Close any holes in your attic to ensure that your neighborhood bats use your outdoor wildlife habitat, and not your house!

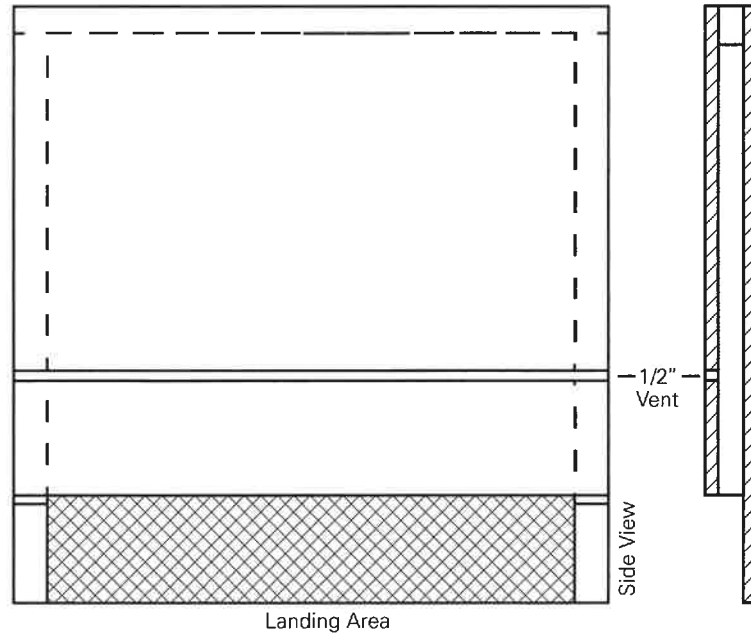

side.

Procedure

Preparation

1. Measure and cut plywood into three pieces for each group: 26 1/2" x 24" for the back board, 16 1/2" x 24" for the front top, 5" x 24" for the front bottom.
2. Pre-drill 11 screw holes on the back board, four on each side and three across the top.
3. Pre-drill nine screw-holes on the front top board, three on each side and three across the top.
4. Pre-drill four screw holes on the front bottom board, two on each

1. Ask students, *What do you know about bats?* Make a list on the board. *What would you like to know?* Make a parallel list. Discuss some of the major characteristics of bats (from background) with the students, and refer back to their list for later explorations.
2. Explain to students that many bats are highly endangered (*What does that mean?*) due to habitat destruction and disturbance. *If you live in an area bats use for habitat (check www.enature.com if you need to check), what could you do to help them?* One idea is to build a bat house to provide additional habitat for them.
3. Divide your students into small groups to make bat houses, or make one together as a large group. Make sure to use all appropriate safety considerations, equipment, and adult supervision for use of tools.
4. Roughen inside of backboard and landing area by cutting horizontal grooves with sharp object or saw. Space grooves about 1/2" apart, cutting 1/32" to 1/16" deep. Ask students, *why you might want to do this?* (The bats need such texture for climbing and roosting.)
5. Apply two coats of black, water-based stain to interior surfaces. Do not use paint, as it will fill grooves, making them unusable.
6. Measure and cut furring strips into one 24" and two 20 1/4" pieces.
7. Attach furring strips (3/4" wide) to back, caulking first. Start

Bat House Color

Recommendations Based on Average Daily High Temperatures in July

Less than 85° F	=	black
85° to 95° F	=	dark brown or other dark shade
95° to 100° F	=	medium brown or other medium shade
100° F or greater	=	light tan or other light shade

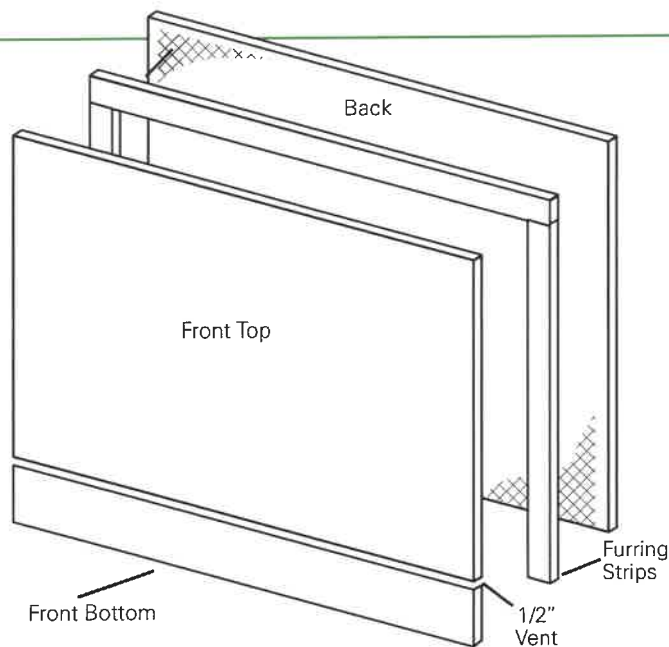

with 24" piece at top. Roosting chamber will be 3/4" wide (front to back).

8. Attach front to furring strips, top piece first (don't forget to caulk wherever pieces meet along both top and sides). Leave 1/2" vent space between top and bottom front pieces.
9. Caulk around all outside joints to further seal roosting chamber.
10. Attach a 1" x 3" x 28" board to the top as a roof, if desired (optional, but highly recommended).

KEY CRITERIA FOR SUCCESSFUL BAT HOUSES



©Michael Wehaff/iStockphoto.com

- Include vents 6 inches from the bottom of all houses to be used where average July high temperatures are 85° F or above. Front vents are as long as a house is wide; side vents are 6 inches tall by 1/2 inch wide.

HABITAT:

Most nursery colonies of bats choose roosts within 1/4 mile of water, preferably a stream, river, or lake. Greatest bat house success has been achieved in areas of diverse habitat (with lots of different species present). Bat houses are most likely to succeed in regions where bats are already attempting to live in buildings.

DESIGN:

All bat houses should be at least 2 feet tall and 14 inches or more wide, with a landing area extending below the entrance at least 3 to 6 inches.

- Most houses have one to four roosting chambers — the more the better. Roost partitions should be carefully spaced 3/4 to 1 inch apart.
- All partitions and landing areas should be roughened. Wood surfaces can be scratched or grooved horizontally, at roughly 3-inch intervals, or covered with durable plastic mesh. Plastic mesh **MUST** be securely stapled every two inches. (Plastic mesh 1/8" or 1/6", but no larger than 1/4", available from companies such as Internet, Inc. at www.industrialnetting.com or 1-800-328-8456).



©Jason Patrick Ross/Shutterstock.com

11. Paint or stain exterior three times (use primer for first coat).
12. Where will you put up your new bat house? Ask students to identify criteria for good placement, based on what they know about bats. Consider:
 - permission to put it up, close to a pond, stream, or lake where bats feed and drink,
 - diverse habitat that supplies a variety of insects,
 - lots of sunshine to warm the house (at least six hours daily in hot climates, more in cool locations, so young stay warm and grow fast),
- facing east, west, or south (avoiding west in exceptionally hot climates),
- on a pole or the side of a building),
- about 12-15 feet above ground,
- in an open area at least 20 feet away from nearest trees or other obstacles. For each of these factors, ask students to consider how it contributes to successful bat habitat.
13. Install your bat house and observe it! What do you discover?

Assessment

- Write a letter to Ranger Rick Raccoon at the National Wildlife Federation about your bat house, explaining what you learned about building and planning your bat house. Ask any bat-related questions you have.



©Linda Charlton / iStockphoto.com



©Jeff Kinsey / Shutterstock.com



©Arsjera / Shutterstock.com

MOUNTING:

Bat houses should be mounted on poles or buildings. Houses mounted on trees or metal siding are seldom used. Wood or stone buildings with good solar exposure are excellent choices, and locations under the eaves often have been successful. Mounting two bat houses back to back on poles is ideal. Place houses 3/4 inch apart and cover both with a galvanized metal roof to protect the center roosting space from rain. All bat houses should be mounted at least 12 feet above ground; 15 to 20 feet is better.

PROTECTION FROM PREDATORS:

Houses mounted on sides of buildings or on metal poles provide the best protection from predators.

AVOIDING UNINVITED GUESTS:

Wasps can invade bat boxes before bats fully occupy it. Use of 3/4-inch roosting spaces reduces wasp use. If nests accumulate, they should be removed in late winter or early spring before either wasps or bats return. Open-bottom houses greatly reduce problems with birds, mice, squirrels or parasites, and guano (bat droppings) does not accumulate inside. **TIMING:** Bat houses can be installed at any time of the year, but are more likely to be used during their first summer if installed before the bats return in spring.

What you can do to help bats



Visit National

Wildlife Federation

at www.nwf.org

to learn about all kinds

of wildlife and

habitat protection.

© Janet Tyburec, Bat Conservation International, www.batcon.org



You can make a big difference for bat conservation by working on local projects. The following suggestions can get you started in your community.

Actions That Everyone Can Take:

- Write an article about bats for your local newspaper, especially for International Bat Night (each year on Saturday of the last full weekend in August), International Bat Appreciation Week (each year in the second week of April), or Year of the Bat.



© Merlin D. Tuttle, Bat Conservation International, www.batcon.org

- Learn how to safely remove stray bats from living quarters. This can be done easily by covering the bat with a coffee can when it lands and slipping a piece of cardboard between the wall and the opening. The bat then can be released outside. Do not attempt to handle bats without gloves; they may



- bite in self-defense. Share this with neighbors and friends.
- Provide bats and rabies facts to local school, garden centers, public parks and after-school centers. To obtain information about bats and public health issues, visit www.batcon.org and click on “Bats and Rabies”.
 - Teach a unit on habitats and wildlife. Exciting activity guides are available both through BCI and NWF.
 - Build a Certified Wildlife Habitat® at school, home or a park, complete with native plants, bird feeders, bee-attracting flowers, and other food, water, shelter, and places to raise young for all your local wildlife. To find out more, visit www.nwf.org/gardenforwildlife.
 - Organize a wildlife appreciation day at your school and educating other students about the importance of wildlife and habitat.
 - Visit sites to view wild bats and bats in zoo conservation programs.
 - Promote the “look, but do not touch” approach of respecting wild animals.
 - Host a fundraiser to support bat research and improving bat conservation.
 - Contact your local wildlife resource center to assist with bat rehabilitation.
- Additional Activity Ideas**
- Use the zip code finder on eNature.com to identify what bats are located in your community.
 - Watch for bats and participate in citizen science programs with Project Noah (www.projectnoah.org) or Wildlife Watch (www.nwf.org/watch)
 - Download activities for families, groups and teachers, including how to build and install a successful bat house (www.batcon.org)
 - Participate LIVE or view pre-recorded webinars about bats, their habitats, how to teach about bats and much more at BatsLIVE (<http://batlive.pwnet.org/>)
 - Explore the Year of Bat and activities you can do over the year and beyond (www.batcon.org/YOTB)
 - Join “NIGHT” summer reading program sponsored the National Libraries. Check out great books and read outside.
 - Participate in a bat awareness program at your local zoo or aquarium. Find activities in your area at www.batcon.org/aza

Further Resources

More Resources available on Year of Bat Partners websites

- USDA Forest Service (www.fs.fed.us)
- Partners in Resource Education (www.handsontheland.org)
- US Fish and Wildlife Service (www.fws.gov)
- Bat Conservation International (www.batcon.org)
- National Environmental Education Foundation (www.neef.org)
- EUROBATS Organization for Bat Conservation (www.eurobats.org)
- National Wildlife Federation (www.nwf.org)
- Bureau of Land Management (www.blm.gov)
- Lubee Bat Conservancy (www.batconservancy.org)
- Virginia Department of Conservation & Recreation (www.dcr.virginia.gov)
- UN Year of the Bat (www.yearofthebat.org)
- National Park Service (www.nps.gov)
- National Cave and Karst Resources Institute (www.fs.fed.us)
- Project Underground (<http://karsteducation.org/>)
- Organization for Bat Conservation (www.batconservation.org)
- Ravenswood Media
- Prince William County Public Schools (<http://batlive.pwnet.org/>)
- Midwest Bat Working Group (<http://mwbwg.org/>)
- Western Bat Working Group (www.wbwg.org)





©Cheryreck / BigStockPhoto.com

©South12th / BigStockPhoto.com



©Zalain / Shutterstock.com



©Eric Iselle / Shutterstock.com



©Canoner / Shutterstock.com



©Kushal Rowe / Shutterstock.com



©Ivan Kuzmin / Shutterstock.com



©Ivan Kuzmin / Shutterstock.com



**NATIONAL
WILDLIFE
FEDERATION**[™]

National Wildlife Federation
11100 Wildlife Center Drive
Reston, VA 20190-5362

800-822-9919